

MicroBlaster



USER MANUAL



1. Introduction	2
2. Technical specifications.....	2
3. Package content.....	2
4. Main characteristics of the model.....	3
5. Main items of the product.....	3
6. Installation instructions.....	4
7. Use instructions.....	5
8. Maintenance and cleaning.....	6
9. Safety precautions.....	6
10. Warnings.....	8
11. Special storage conditions.....	9
12. Problems and solutions.....	9
13. Symbols.....	10
14. Term of warranty and technical assistance.....	10
15. Authorized technical assistance.....	11
16. European authorized representative.....	11

Watch the video:



► 1. INTRODUCTION ◀

Bio-Art Microblaster is a portable pneumatic device, easy to install and operate, designated to surface blasting, mainly in dental works.

The use of Microblaster in dentist's offices and dental laboratories has more and more been requested for being practical, ergonomic and accurate in small jobs and/or where the area to be blasted has a slight contact with areas of preservation from blasting.

Bio-Art Microblaster is provided with an ejecting needle made of sintered carbide, which assures higher durability and accuracy during blasting.

Bio-Art has developed three Microblaster models depending on the purpose:

Microblaster Standard and Lab Models

One fixed nozzle mounted at a 138° angle.



Microblaster Plus Model

Two removable and autoclavable nozzles, mounted at 90° and 138° angles.



Attention! Before operating the equipment, read carefully all instructions contained in this manual.

► 2. TECHNICAL SPECIFICATIONS ◀

Weight of Microblaster Standard and Lab without the package:.....	65g
Weight of Microblaster Plus without the package.....	70g
Weight of Microblaster Standard and Lab with the package.....	210g
Weight of Microblaster Plus with the package:.....	215g
Package dimension (W x T x H).....	190 x 133 x 50 mm
Work pressure.....	60 a 80 lbf/pol ² (4~5,5 Kg/cm ²)
Granulation of the supported aluminum oxide:.....	up to 100 microns

► 3. PACKAGE CONTENT ◀

When opening the package, check for the presence of the following items inside, according to the specified model:

Microblaster Standard and Lab Models:

- 01 Microblaster with fixed nozzle and ejecting needle at 138°;
- 01 Quick coupling;

- 01 Handpiece Connector;
- 01 A tank with 40g aluminum oxide 50 microns;
- 01 Instruction Manual.

Microblaster Plus Model:

- 01 Microblaster;
- 01 Removable nozzle with ejecting needle at 90°;
- 01 Removable nozzle with ejecting needle at 138°;
- 01 Quick coupling;
- 01 Handpiece Connector;
- 01 A tank with 40g aluminum oxide 50 microns;
- 01 Instruction Manual.

▶ 4. MAIN CHARACTERISTICS OF THE MODEL

Characteristics	Standard	Lab	Plus
Fixed nozzle with ejecting needle at 138°	Yes	Yes	No
Removable nozzles with ejecting needles at 90° and 138°	No	No	Yes
Autoclavable nozzles	No	No	Yes
Use of aluminum oxide with granulation up to 100 microns	Yes	Yes	Yes
Possibility for intraoral use	Yes	No	Yes
Exclusive use in laboratories	No	Yes	No

▶ 5. MAIN ITEMS OF THE PRODUCT

Microblaster Standard and Lab Models:

- 01 - Ejecting needle
- 02 - Fixed nozzle 138°
- 03 - Microblaster Body
- 04 - Switch button
- 05 - Lid of the tank for abrasive
- 06 - Tank for abrasive
- 07 - Quick coupling for use on compressor
- 08 - Engaging nut for fixation of the PU hose
- 09 - Handpiece Connector
- 10 - Nut with spigot

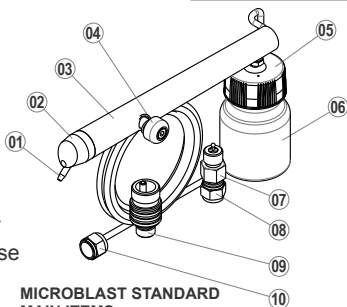

**MICROBLAST STANDARD
MAIN ITEMS**

Microblaster Plus Model

- 01 - Ejecting needle
- 02 - Removable nozzle 138°
- 03 - Microblaster body
- 04 - Switch button
- 05 - Lid of the tank for abrasive
- 06 - Tank for abrasive
- 07 - Quick coupling for use on compressor
- 08 - Engaging nut for fixation of the PU hose
- 09 - Handpiece Connector
- 10 - Nut with spigot
- 11 - Removable nozzle 90°
- 12 - Nut for fixation of the removable nozzles 90° and 138°

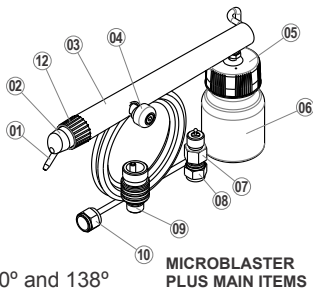

▶ 6. INSTALLATION INSTRUCTIONS ◀

The Bio-Art Microblaster shall be installed by means of a nut with a spigot (10) in a pure and dry compressed air network.

For the equipment and the user's safety, and for better performance during the blasting works, make sure the compressed air pressure is kept stable at 60 to 80 lbf/inch² (4~5.5 Kgf/cm²).

Bio-Art supplies the connections (07, 08 and 09) together with the product, aiming to facilitate their connection during installation, considering that it can be connected to a standard compressed air network or to the equipment low rotation terminal, as described in the illustration below:

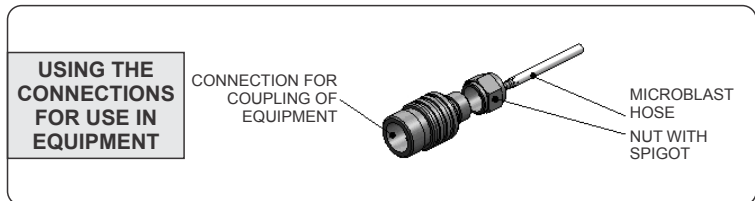
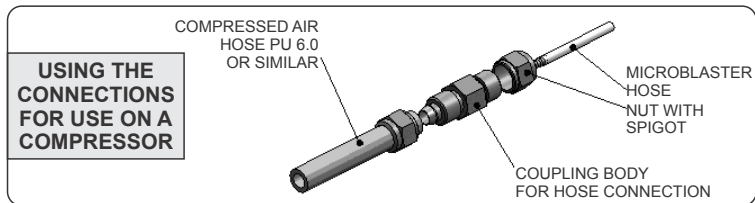

After the Microblaster installation has been finished, correctly follow the use instructions and the other information about precautions and safety, described below.

7. USER INSTRUCTIONS

1-Remove the switch button clamp (04).



When removing the switch button clamp (04), try using it immediately afterwards and always after using Microblaster, return the respective clamp to the button (04) thus keeping it always pressed. The act of keeping the button clamp released for long periods might generate adherence of the internal driving tube walls, which might make the oxide passage difficult.

2-Microblaster Plus model is provided with two removable and autoclavable nozzles (02 and 11) offering two options for the ejecting needle angling, one at 90° (indicated for intraoral works on posterior teeth) and another at 138° (indicated for laboratory works and intraoral works on anterior teeth). According to the kind of work to be carried out, fix one of the nozzles on the Microblaster body by means of the fixing nut (12).



During the nozzles removal or fixation (02 or 11) on Microblaster Plus, firmly hold the nozzle with the fingers of one hand without turning it and then turn the connecting nut with the fingers of the other hand (12), thus fixing or releasing the chosen nozzle by means of the nut thread.



Never use any kind of wrench or tool to fix or release the nozzle on Microblaster Plus.

Note: Nozzle (02) used in the Microblaster models allows rotation up to 180°, facilitating the performance of very different kinds of works.

3- Fill the tank (06) in to maximum $\frac{3}{4}$ of its capacity with aluminum oxide and fix it on the tank for abrasive lid (5) located at the end of the Microblaster body.



Use only abrasives of the type aluminum oxide and with granulations in the range up to 100 microns.

Note: Bio-Art commercializes the perfect aluminum oxide for consumption and refill to be used with Microblaster.

4- With the tank duly filled in and introduced in Microblaster, press the switch button (04) to start the blasting process.

Remark:

If the blasting is interrupted for any reason even with the switch button (04) pressed and the tank (06) filled in with abrasive, follow the steps below:

- keep the switch button (04) pressed;
- with the other hand, hold the hose firmly in the region close to the end of the Microblaster body, pulling slightly and releasing immediately afterwards;
- repeat this procedure until the air passage is free.

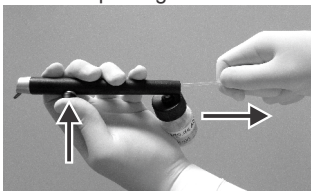

5- Always try to keep a distance from 5 to 10 mm between the face of the Microblaster needle tip (01) and the surface to be worked during blasting.

Important note:

- In order to obtain better results during the blasting works, make small fast and constant movements throughout the whole surface to be blasted.
- Some recommendations for the aluminum oxide granulation, indicated for some application examples are presented below. It is upon the professional's discretion to choose the best applicable granulation, provided that it is supported by Microblaster (up to 100 microns).

Applications	Granulation
Micro-retentions (surface roughness)	50 microns
Bracket recycling (cleaning)	90 microns
Internal "inlay-onlay" cleaning of resin and ceramics	50 microns
Cleaning or degreasing of metal and/or ceramics when the "intraoral ceramic repair technique" is used	50 microns
Occlusal blasting for fine-tuning, replacing the use of carbon	50 microns
Internal evidencing for crown adjustment and seating	50 microns
Adjustment of interproximal contacts	50 microns
Removal of cement from metal crowns, resins, ceramics and other materials	90 microns
Cleaning of cast parts	90 microns
Removal of oxidation	90 microns



Bio-Art Microblaster is equipment exclusively designed to produce a abrasion function blast, without prophylaxis function, i.e., there is no any similarity with sodium bicarbonate blasting equipment.

▶ **8. MAINTENANCE AND CLEANING** ◀

Before disconnecting Microblaster from the compressed air network or the equipment, remove the tank for abrasive (06) and then place your finger on the tip of the ejecting needle (01) closing the needle orifice, and simultaneously press the switch button (04) for approximately three seconds for the internal hose to totally empty the abrasive that might still be in the system. This process is called “Retro-blasting”.



The “Retro-blasting” procedure shall not be executed for more than five seconds, which might cause breakage of the tank for abrasive (06).

For the Microblaster cleaning and disinfection, use only a cloth dampened with water or alcohol 70%.



Bio-Art Microblaster shall never be sprayed with liquids; be submerged or sterilized in an oven or an autoclave, except for the removable nozzles (02 and 11) in the Plus model, which, after being released from the product, can be sterilized in autoclaves.

Keep the compressed air network always free of moisture and oil, always observing the efficiency of your compressor's coalescent filters.

For model Microblaster Plus, whenever changing the nozzles (02 and 11), carefully clean the nozzles' and the fixation nut's (12) thread in order to eliminate possible aluminum oxide residues or dust and to avoid their damage or locking.

▶ **9. SAFETY PRECAUTIONS** ◀

Intraoral Use:



Bio-Art Microblaster was developed for general use and mainly for application in laboratories. Its intraoral use can be based on health, safety rules and restricted to the exclusive technical responsibility of the Dental Surgeon or the responsible professional.



Due to the constructive features of the Microblaster Lab model, its use shall be restricted to laboratories, thus it is not indicated for intraoral procedures.



The Dental Surgeon or the responsible professional are fully responsible for the product use, regarding the safety items, the environment, the operator's and the patient's personal protection, indications and contra-indications and side effects.

Bio-Art denies any responsibility for any damage caused by undue use of Microblaster and in cases where the safety items described in this document have not been complied with.

General and laboratory use:

The Use of personal protective equipment (PPE's) when working with Bio-Art Microblaster is compulsory. Use protection goggles, gloves and breathing mask when operating the equipment.

In addition to these EPI's and for cases when the work offers such conditions, we recommend the use of the Bio-Art Bio-Chamber (suction chamber).



Using Bio-Art Bio-Chamber (suction chamber):

Bio-Art BIO-CHAMBER, (not included) is a complementary product for use with Microblaster. Manufactured by Bio-art, it is an exhaustion chamber used in the blasting processes with the purpose not to allow the excess of aluminum oxide and the impurities generated in the blasting process to be launched to the environment.

Bio-Art BIO-CHAMBER is provided with an exclusive exhaustion system and a blasting chamber with high visibility and exclusively designed to work with Microblaster, thus providing higher cleaning, speed, efficiency, safety and practicality in the blasting processes.

▶ 10. WARNINGS ◀

- Never point the ejecting needle (01) to any part of the body during the blasting process.
- Use only abrasive of the type aluminum oxide.

- The aluminum oxide used in Microblaster might cause skin, eye and respiratory tract irritation. Never use Microblaster without personal protective equipment (PPE).
- Never use aluminum oxide with traces of moisture or contaminants.
- Never use aluminum oxide with granulation out of the manufacturer's specification (up to 100 Microns).

▶ 11. SPECIAL STORAGE CONDITIONS ◀

Bio-Art Microblaster shall be stored under the following conditions:

- With the clamp installed on the switch button (04), keeping it always pressed.
- Always disconnected from the compressed air network and/or the equipment;
- In a cool, dry and free of dust place;
- Far from chemical products and protected from sources of heat and sun light;
- Preferably in its original packaging.

▶ 12. PROBLEMS AND SOLUTIONS ◀

Problem	Cause	Solution
Air and/or abrasive flow missing, or insufficient at the ejecting needle (01) ***.	Incorrect connection of Microblaster to the compressed air network.	See item 6 of this user manual and install Microblaster correctly.
	Insufficient or instable compressed air network pressure.	See item 6 of this user manual and monitor the correct pressure. (60 to 80 lbf/inch ² (4~5.5 Kg/cm ²)).
	Throttling of the driving hose by the button lever.	See item 7, part 4 of this user manual.
	Insufficient quantity of abrasive (aluminum oxide) in the tank (06).	Fill the tank (06) in with aluminum oxide at maximum of 3/4 of its capacity.
Clogging***.	Presence of moisture in the compressed air system.	The compressed air network shall be dry. Check the coalescent filter efficiency and the presence of moisture.
	Presence of moisture in the abrasive.	The abrasive shall be free of moisture, with humid weather it is necessary to pre-dry in an oven or an open pot at 250°C for 30 minutes.
	Incorrect granulation, out of specification in the user manual.	Use only abrasive of the type aluminum oxide up to 100 microns, preferably supplied by Bio-Art itself.
	Reuse of abrasives containing residues ("recycling" attempt).	The excess of aluminum oxide in the blasting shall be disposed.
Air leaking on the Microblaster body.	Internal driving hose damaged.	Contact the Authorized Technical assistance Service.
Air leaking through the ejecting nozzle needle.	Displacement of the driving lever internal hose.	Contact the Authorized Technical assistance Service.

***In case of clogging in the Microblaster internal pipeline, a simple "Retro-blasting" procedure might solve the problem. For this purpose, see the information described in item 8. Maintenance and cleaning of this user manual.

▶ 13. SYMBOLS

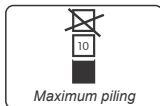
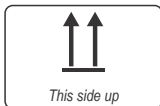
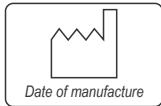

▶ 14. TERM OF WARRANTY AND AUTHORIZED TECHNICAL ASSISTANCE

BIO-ART Equipamentos Odontológicos Ltda., grants a six-month warranty for this product, starting from the date of its acquisition. This warranty covers all and any manufacturing defect, being provided through repair of the equipment, and subjected to the following requirements:

- That the product has been used correctly in accordance with the instructions described in the user manual;
- The claim is accompanied by the purchase invoice and registered within the warranty period, followed by a report with description of the defect and the product serial number;
- The product is handled, transported and stored with care;
- The transport cost (round trip) is paid by the customer;

Warranty limitations:

- Natural wear of parts;
- Misuse, falls or accidents;
- Inadequate transport;
- Repair by non-authorized personnel;
- Use in disagreement with the device features and purposes;
- Wear due to exposure to adverse conditions (humidity, cold and intense heat);
- Damage due to lack of cleaning or maintenance with inappropriate products;

In case of doubts, contact the manufacturer:



BIO-ART EQUIPAMENTOS ODONTOLÓGICOS LTDA
Rua Teotônio Vilela, 120 – Jardim Tangará
Zip Code 13568-000 – São Carlos – SP – Brazil
Tel. +55 (16) 3371-6502 – Fax +55 (16) 3372-5953
CNPJ 58.538.372/0001 – State Regis. 637.034.447.113
www.bioart.com.br

▶ 15. AUTHORIZED TECHNICAL ASSISTANCE ◀

For your safety, technical assistance on this product shall only be provided by authorized personnel/companies. See our site www.bioart.com.br for the Authorized Technical assistance posts.

▶ 16. EUROPEAN AUTHORIZED REPRESENTATIVE ◀



OBELIS s.a
Boulevard Général Wahis 53 - 1030 Brussels, BELGIUM
Tel: +(32) 2. 732.59.54 - Fax: +(32) 2.732.60.03
E-Mail : mail@obelis.net



Rua Teotônio Vilela, 120 - Jd. Tangará - CEP 13568-000 - São Carlos - SP - Brasil
Tel. +55 (16) 3371-6502 - Fax +55 (16) 3372-5953
www.bioart.com.br