

PERIOTEST® M

Operating Instructions
English

Medizintechnik Gulden

Manufacturer of the Periotest



Medizintechnik Gulden e.K.

Operating Instructions

Electrical measuring instrument for dentistry and dental implantology

PERIOTEST[®] M

Electrical measuring instrument for dentistry and dental implantology

Operating Instructions
English

About this document

Dear Customer,

Thank you for purchasing the Medizintechnik Gulden Periotest M.

The technical documentation supplied is part of the product and always must be kept within easy reach. Please read these Operating Instructions carefully and familiarize yourself with the Periotest M.

If you encounter unsolvable problems after thoroughly studying the Operating Instructions, please contact your dental depot or the manufacturer.

Symbols used in the Operating Instructions

To prevent any personal injury or material damage, please observe the warning and safety information provided in the present operating instructions. All such information is highlighted as follows:

NOTE

Additional information, explanation or supplement.

CAUTION

The information provided under this keyword directly concerns the functioning of the product and / or warns against possible operating errors.

WARNING

The warning symbol warns against possible hazards for the product or the user.

**Symbols used in these
Operating Instructions as well
as on the product and the
package**

VAC

(volts alternating current): Alternating current in volts.

VDC

(volts direct current): Direct current (DC) in volts.



Serial number of the unit



Electrical protection class: II (double insulation, complies with the requirements of IEC 60601-1.



Part applied to patient: Type B.



Manufacture date: Date written as year-month.



Name and address of the manufacturer.



Disposal: This product must not be disposed with household garbage.



Order number / item number



Storage and transport conditions



Temperature: The product must not be stored and transported at temperatures ranging outside of -20 °C and +50 °C (-4 °F and +122 °F).



Air pressure: Permissible atmospheric pressure: 500 to 1060 hPa.



Humidity: Permissible relative humidity: 20 to 90 %.



Observe information in accompanying documents.



Fragile; handle with care.



Protect from moisture.



This product bears the CE mark in accordance with the provisions of Council Directive 93/42/EEC of June 14, 1993 concerning medical devices.

Item number and Version of
Operating Instructions

REF 8920165
Version 2018-02-15

Contents

	Page
1. Warning and safety information	
1.1 General safety information	8
2. Technical information	
2.1 Technical description	11
2.2 Technical data	12
2.3 Service life of Periotest instruments	14
3. Scope of supply	14
4. Installing the Periotest M	15
5. Controls and functional elements	17
6. Operation	
6.1 Putting the unit into operation	18
6.2 Functional test	19
7. Conducting measurements with the Periotest M	
7.1 Sitting position of the patient	20
7.2 Point of application at the tooth / implant	20
7.3 Posture of the Periotest M	21
7.4 Measurement procedure	23
7.5 Point in time of measurements at dental implants	24
7.6 Measurement of the occlusal load	24
8. Meaning of the Periotest values	25
9. Care and cleaning	
9.1 Cleaning and disinfection	27
9.2 Sterilization of the Periotest M probe	29
10. Battery	
10.1 Charging the battery	30
11. Maintenance	31
12. Electromagnetic compatibility	32

1 Warning and safety information

1.1 General safety information

It is very important to make sure that this manual is stored together with the unit so that it will also be available at any time in the future. In case the unit is sold or the right to use is transferred to a different owner, make sure that the manual always remains located near the unit. This is necessary to ensure that the new owner can use the unit properly and has all required information.

Retention of documentation

Read carefully before starting!



These instructions serve to promote safety. Be sure to read them carefully before installing and using the unit.

This symbol is attached at the Periotest M to remind the user to observe the manual.

Medical electrical devices may be used with reference to the risk of electrical shock, fire or mechanical hazards, according to IEC 60601-1 only.

Intended use

The Periotest M is an electrical measuring instrument for dentistry and dental implantology. It may be used only by qualified dental personnel.

Modification of the device

The device must not be modified without the permission of the manufacturer.

Disclaimer

The manufacturer assumes no liability whatsoever in cases involving:

- work or repairs performed by any personnel not authorized by the manufacturer or importer
- an application which does not correspond to the ones described in this manual
- the use of non-OEM components or any components not described in the section entitled **Scope of supply**.

Electromagnetic compatibility To prevent potential risks from electromagnetic interference, no medical devices or other electronic devices may be operated in the immediate vicinity of the Periotest M (see Chapter 12 for recommended working clearances between Periotest M and portable and mobile RF communication devices).

The device meets the currently applicable guidelines for electromagnetic compatibility (IEC 60601-1-2). This unit does not cause any harmful interference.

However, it can receive interference from other devices, such as wireless transmitters, mobile communication devices, and other household appliances, including interference that may lead to undesirable functions. Special EMC precautions are required for the installation and operation of the Periotest M. These Operating Instructions contain the corresponding EMC information.

Operating environment Never use this unit in the presence of flammable anesthetics or anesthetic agents mixed with air, oxygen or nitrogen.

Malfunction or damage In case of malfunction or damage of the unit, stop using it immediately. Damaged instruments can cause injuries. Contact your dental dealer or the manufacturer.

Connected devices The Periotest M may be used only with the supplied probe. The use of a different probe may lead to wrong readings.

Sterilization Maximum sterilization temperature for the probe: 134 °C (273 °F).

Power supply

The Periotest M is powered by a storage battery. The supplied power supply unit and the charger unit are used only to charge the battery, but not to operate the Periotest M. Do not use other charging devices than the supplied power supply unit and the supplied battery charger.

Battery

The Periotest M is equipped with a built-in battery. Do not try to open the Periotest M casing and change the battery by yourself. The battery may only be replaced by an authorized dealer or the manufacturer.

Side effects

Until now, no side effects (e.g. necrosis) have been determined in connection with clinical use of the Periotest M.

Return shipment for repair

Parts returned for repair must always be disinfected prior to shipment to ensure that no innocent bystander is infected when unpacking and transporting them.

Disposal

It generally applies that any disposal of this product must comply with the relevant national regulations. Please observe the regulations applicable in your country. Within the European Economic Community, Council Directive 2002/96/EU (WEEE) requires environmentally sound recycling / disposal of electrical and electronic devices. Your product is marked with the adjacent symbol. Disposal of your product with domestic refuse is not compatible with the objectives of environmentally sound recycling / disposal. The black bar underneath the „garbage can“ symbol means that it was put into circulation after August 13, 2005 (see EN 50419:2005). Please note that this product is subject to Council Directive 2002/96/EU (WEEE) and the applicable national law of your country and must be recycled or disposed in an environmentally sound manner. Please contact your dental depot if final disposal of your product is required.

2 Technical information

2.1 Technical description

The Periotest M is an electrical measuring instrument for use in dental practices. It is designed for the following range of applications:

- Assessment of the osseointegration of dental implants
- Diagnosis and assessment of periodontopathies. The Periotest M measures the damping characteristics of the periodontium and, indirectly, tooth mobility, which it outputs in the form of a Periotest value.
- Assessment of the occlusal load
- Control of the treatment's progress.

The instrument's scale ranges from -8.0 to +50.0. The unit of measure is „Periotest values“. Periotest values correspond to the contact time of the probe with the measured object (tooth, implant). A short contact time corresponds to a low Periotest value, while a long contact time corresponds to a high Periotest value.

The Periotest M is the result of a cooperation between experienced dental technicians and many years of experience in high-end electronics. It represents the state of the art in dental research technology.

Contraindications

The Periotest M should not be applied in the following cases:

- All types of acute apical periodontitis
- Acute trauma (dislocation, root fracture, alveolar process fracture).

2.2 Technical data

Manufacturer	Medizintechnik Gulden e.K.
Model	Periotest M type 3218
<u>Periotest M hand unit data</u>	
Dimensions	Approx. 180 x 31 x 40 mm
Material	
Housing (white parts)	ABS (Flammability HB)
Housing (blue parts)	TPE (Flammability HB)
Probe sleeve	Brass, nickel and chrome plated
Tapping head	Stainless steel X8CrNiS18-9
Weight incl. battery	Approx. 153 g
Noise level	< 65 dBA
Power supply	Battery driven device
Power consumption from battery charger during charging	max. 225 mA
Battery	
type	Lithium-ion polymer
Voltage nominal	7.4 VDC
Capacity typical	250 mAh
Protection against electrical shock	
Protection class	Internal power supply
Degree of protection against electrical shock	Applied part: type B 
Operating mode	Intermittent operation: ON 4 sec. / OFF until next measurement
Housing IP class	IP20

2.2 (continued): Technical data

Energy transfer from the tapping head to the measured object (tooth, implant)	Max. 0.00018 Joule
Weight of the tapping head	Approx. 9 g
Range of the Periotest value scale	-8.0 to +50.0
Unit of measure	Periotest values
Accuracy of measure	Scale range -8 to +19: +/- 1.0 Periotest value Scale range +20 to +50: +/- 2.0 Periotest value
Display resolution	0.1 Periotest value
Operating conditions	Temperature: 15 to 30 °C (59 to 86 °F) Relative humidity: 20 to 90 % Air pressure: 700 to 1060 hPa
Transport and storage conditions	Temperature: -20 to 50 °C (-4 to 122 °F) Relative humidity: 20 to 90 % Air pressure: 500 to 1100 hPa

Periotest M battery charger data

Input voltage	12 VDC
Housing IP class	IP20
Protection class	II
Item number / order number	REF 8916793



Switch mode power supply unit data

Manufacturer	Friwo
Type	FW8002M/12
Input voltage	100 to 240 VAC
Mains frequency	50 to 60 Hz
Output voltage	12 VDC
Output current	600 mA
Housing IP class	IP40
Item number / order number	REF 8916975

2.3 Service life of Periotest M instruments

When used as intended, the non-moving parts of Periotest M instruments have a typical service life of 5 years. Moving parts of Periotest M instruments have a typical service life of 3 years. However, no warranty claim can be inferred here, as wear may occur earlier or later than indicated above depending on use, frequency of sterilization and frequency of maintenance.

If your Periotest M (the unit as a whole, or in parts) or the accessories shall not be used any more, do not dispose the product or the parts with household garbage. They can be posing a risk to the environment. Please return these parts to the manufacturer. Alternatively, there may be local recycling or collection points.

3 Scope of supply

- Periotest M including probe REF 8917140
- Lithium-ion polymer battery (built-in) REF 8917025
- Switch mode power supply unit REF 8916975
- Battery charger REF 8916793
- Test sleeve REF 5950027
- Cleaning brush REF 5245758
- Operating Instructions REF 8920165

4 Installing the Periotest M

Remove the Periotest M and its accessories from the box and lay everything on a table. Before installing the Periotest M inspect everything for damage. Any damage which may have occurred during transport must be reported to the dealer within 24 hours after receipt of the goods. Check the contents of the box for completeness as described in section 3 (Scope of supply).

CAUTION

- This product is intended only for use by trained dental personnel.
- Do not install the Periotest M near direct or indirect sources of heat.
- Prior to initial use, all components of the Periotest M must be disinfected (see section 9).
- The packaging of the unit or its accessories must not be used for sterilization.
- While the battery is charging, make sure that the power supply plug can be easily reached to enable quick and easy disconnection from the mains supply.

The charger should be placed on a level and sturdy surface. Make sure that the charger is in a secure position. Plug the supplied test sleeve into its holder on the rear side of the charger. Connect the charger with the power supply unit. Then plug the power supply unit into a mains socket. The LEDs on the charger and on the power supply unit will both light up green.

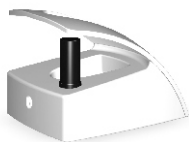

WARNING

- The charger must not be placed in the patient environment while it is connected with the power supply unit.
- Never touch the charging contacts AND the patient.

Place the Periotest M into the charger. The Periotest M battery is being charged. The green LED at the charger starts blinking. Once the battery is fully charged, the LED stops blinking and lights up green constantly.



5 Controls and functional elements

- 1 - Power supply unit
- 2 - Battery charger
- 3 - Periotest M hand unit
- 4 - Test sleeve
- 5 - Cleaning brush
- 6 - Tip of the probe
- 7 - Mounting ring
- 8 - Start button
- 9 - LCD

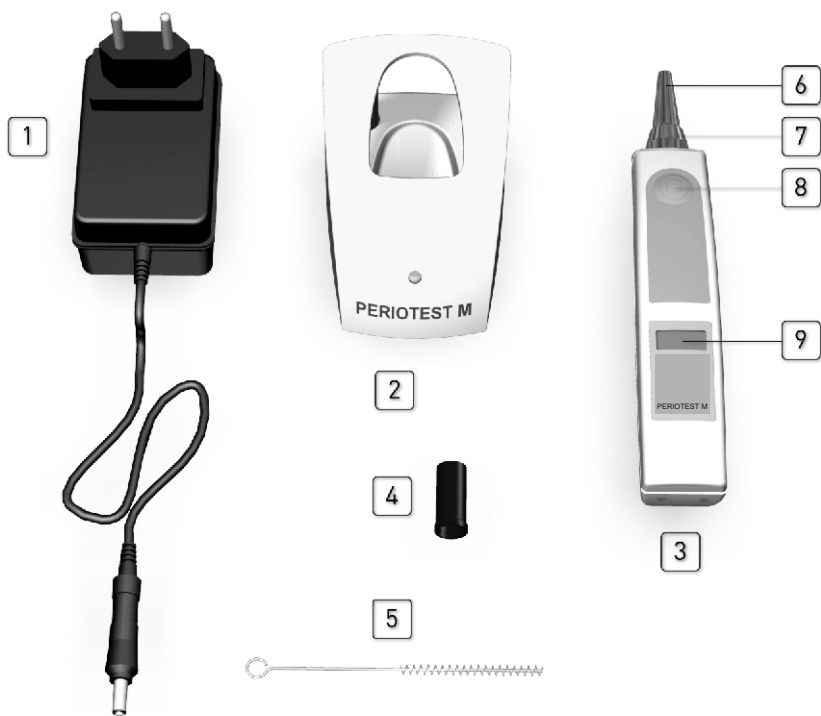

6 Operation

6.1 Putting the unit into operation

The Periotest M is intended solely to be driven by battery. It is not designed for mains operation (100 - 240 VAC).

WARNING

The Periotest M must not be connected with the mains supply (via charger and power supply) during operation.

The Periotest M is disconnected from the mains supply by pulling the power supply unit out of the wall socket. Press the start button to switch on the unit. All segments on the display light up for approx. 2 seconds. Then a short melody plays, the display shows - - - and the Periotest M is ready to conduct measurements.

NOTE

The Periotest M does not have a switch off button. The device switches off automatically after approx. 3 minutes of idle state.

If you have terminated your measurements, put the Periotest M back into the charger.



6.2 Functional test

With the functional test as described hereinafter you verify the correct function and readings of the Periotest M. Please carry out the functional test every time before you take any measurement at a patient.

Visually inspect the device. If you observe damage which could lead to a hazardous situation do not use the device. Contact your dental depot or the manufacturer first.

The functional test is done by measuring the supplied test sleeve. Remove the Periotest M from the charger. Fit the test sleeve onto the tip of the probe. Press the start button to switch on the unit. After 2 seconds a melody plays and the unit is ready to measure. Hold the Periotest M horizontally and press the start button again. The measuring process starts.

After the measuring cycle (approx. 4 seconds - 16 impulses) is finished, the short melody plays again and the reading is indicated on the display. The reading should match the value indicated on the test sleeve. A deviation of +/- 2.0 Periotest values is acceptable. In case of a higher deviation, or in case no reading at all is indicated, the Periotest M does not measure properly. Please observe the instructions in section 9.1 (Care and cleaning). Above all, the probe must be clean and dry, enabling the tapping head to move easily. If cleaning of the probe does not solve the problem, please contact your dealer.

Remove the test sleeve from the tip of the probe and plug it onto the holder on the rear side of the charger.



7 Conducting measurements with the Periotest M

7.1 Sitting position of the patient

Most favourable is an upright sitting position of the patient with a corresponding vertical position of the teeth / implants. But it is also possible to conduct measurements on patients in a lying position.

The teeth of the maxilla and the mandible must not have contact to each other. However, the patient should open his mouth only a little bit and not too wide to enable an easy access to the molar area.

7.2 Point of application at the tooth / implant

To measure natural teeth, the Periotest M must be positioned from vestibularly (buccally, labially) in direction of lingually / palatinally. The tapping head should hit the center of the lateral surface of the tooth.



To measure dental implants, two measuring directions are relevant:

1. Accordingly to the measurement of natural teeth: Position of the Periotest M from vestibularly in direction of lingually / palatinally. Mainly the lingual wall is measured.
2. Alternatively, if anatomically possible and accessible: Position of the Periotest M from lingually / palatinally in direction of vestibularly. Mainly the vestibular wall is measured.

One-piece implants are measured at the upper end of the implant (ball head or similar). Two-piece implants are not measured at the implant itself, but at the implant abutment, the gingiva former or the final crown. The preferred hitting point is right above the gingiva.

7.3 Posture of the Periotest M and positioning at the tooth / implant

In order to get valid, meaningful and reproducible readings, the Periotest M must be held and positioned at the tooth / implant in a particular manner. Please observe carefully the following instructions.

1. Horizontal posture: You only get valid readings if the Periotest M is held (more or less) horizontally. A slight bending upwards or downwards (up to +/- 25°) will be accepted.

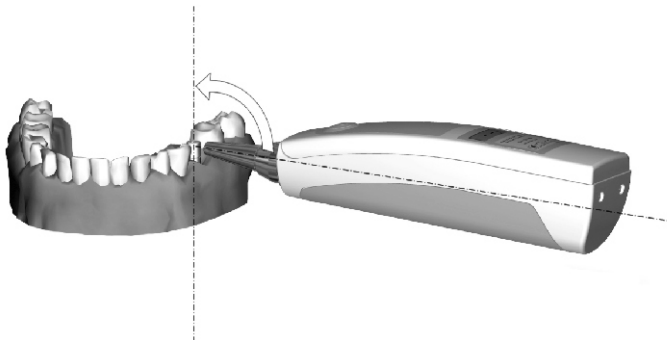

2. Distance between the tip of the probe and the tooth / implant: You need to have a certain distance between the tip of the probe and the tooth / implant. The valid distance is between 0.6 and 2.5 millimeters. If the device is held more closely than 0.6 mm or further away than 2.5 mm, there will be no valid reading. In the beginning it requires a little practice to meet the correct distance. We recommend to make some test measurements at demo tooth models or implants, before starting to measure „real“ teeth / implants.

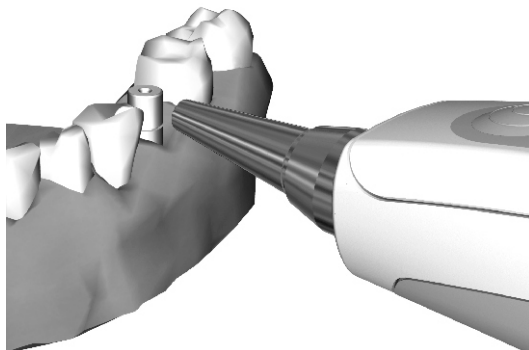

3. Right angle between the Periotest M and the tooth / implant: In order to get readings with the highest accuracy, place the Periotest M in a right angle (Periotest M horizontally, tooth / implant axis vertically). In the molar area, this is not always possible. Deviations up to 45° are acceptable but can lead to slightly different readings (+/- 1.0 Periotest value).

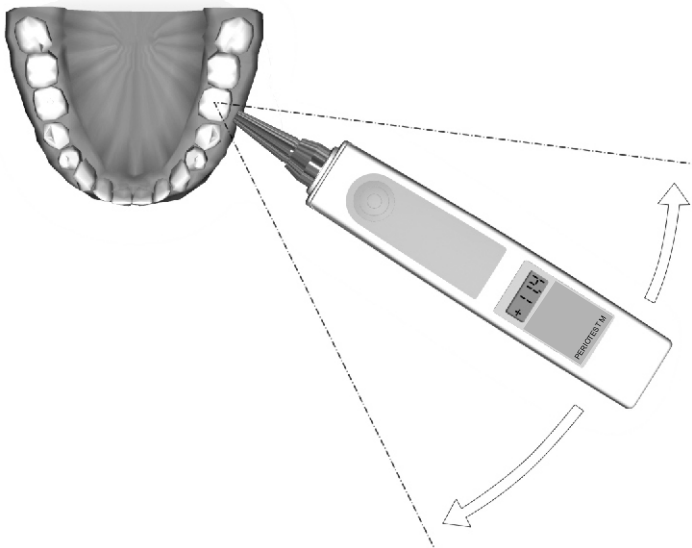
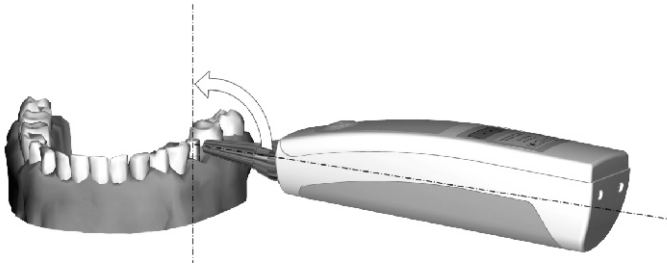

7.4 Measurement procedure

WARNING

Never touch the charging contacts on the rear side of the Periotest M AND the patient.

Press the start button to switch on the unit. All segments on the display light up for approx. 2 seconds. Then a short melody plays, the display shows - - - and the Periotest M is ready to conduct measurements.



Press the start button again to start the measuring process. The measuring cycle consists of 16 impulses of the pressure sensitive tapping head against the measuring object (tooth, implant). For each valid impulse a low tone is emitted. Invalid impulses, for example due to a too high deviation from the correct posture of the Periotest M, are followed by a high tone. You can correct the posture of the Periotest M during the measuring process.

After the measuring cycle (approx. 4 seconds) is finished, the short melody plays again. At least 4 of 16 impulses must be valid in order to get a valid reading. A valid reading is shown on the display. If less than 4 impulses were valid, no reading will be indicated on the display. The display shows --.-.

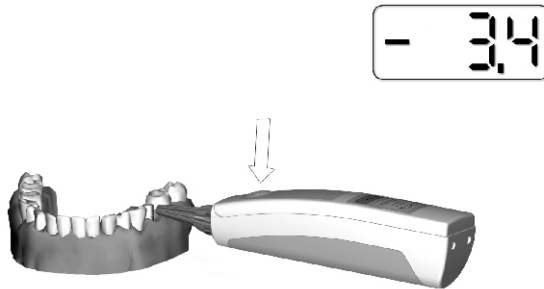

To start a new measurement, press the start button again. The preceding reading will be erased.

If you have finished the measurements, put the Periotest M back into the charger. The Periotest M does not have a switch off button. It switches off automatically after 3 minutes.

7.5 Point in time of measurements at dental implants

You can take measurements in each stadium of the implantological process. Typical points in time are:

- Directly after implant insertion (measuring the primary stability)
- After the healing phase
- After the final crown is installed

7.6 Measurement of the occlusal load

To measure occlusal load, the patient should press his teeth together as if swallowing (to attain maximum intercuspitation). The measurement can be taken on the upper jaw with the teeth rows closed. To check occlusal adjustment, it is also possible to take measurements on the lower jaw.

8 Meaning of the Periotest values

General

The Periotest scale ranges from -8.0 to +50.0. The smaller the Periotest value, the higher the stability / damping degree of the tooth / implant.

ATTENTION

The Periotest M is a measuring instrument which has been extensively tested and proven for many years. Nevertheless, it cannot be excluded that the device is not working properly and the readings are not correct. For legal reasons, we need to point out that before starting any medical treatment you must not rely solely on the measured Periotest value. You rather need to collect more data to assure your diagnosis.

Measurement of natural teeth

Clinical degree of tooth loosening	Periotest value
0	- 8.0 to +9.9
I	+10.0 to +19.9
II	+20.0 to +29.9
III	+30.0 to +50.0

Furthermore, tables for natural teeth are available, showing Periotest values that can be expected in case of a healthy periodontium, for each tooth separately. Please see the professional literature for more information.

Measurement of dental implants

Nowadays, a wide range of implant systems is available on the market. In principle, the Periotest M can be used at all of them. However, due to this multitude of implant systems, and the variation of the clinical situations, with regard to the meaning of the Periotest values, we can only give guideline values which represent a high and a low implant stability (osseointegration).

Periotest value range	Interpretation
-8.0 to 0.0	Good osseointegration; the implant can be loaded
+0.1 to +9.9	Clinical examination is required; loading of the implant might or might not be possible, depending on implant type and clinical situation
+10.0 or higher	Osseointegration is insufficient, the implant cannot be loaded

Generally, in the first 2 - 3 weeks following implantation, implants lose a certain amount of stability. This is reflected by an increase in the Periotest values. After the healing phase, however, the Periotest values should be similar or lower to those immediately following implantation (primary stability). Persistent and significant higher Periotest values indicate either a destabilization of the implant, or a screw loosening, or an overloading of the implant, or an infection (e.g. periimplantitis). It is recommended to record the measured data, enabling to compare the different readings taken over time.

9 Care and cleaning

ATTENTION

Only the Periotest M probe can be sterilized. All other parts can not be sterilized.

9.1 Cleaning and disinfection

Cleaning and disinfecting the surfaces

After every use, the Periotest M must be disinfected or sterilized.

Wipe off surfaces with surface disinfectants (wipe disinfection). You must choose only disinfectants that comply with the valid requirements of the respective national regulatory body or whose bactericidal, fungicidal and virucidal properties have verifiably been tested and approved accordingly. You can use for instance: PlastiSept cleaning foam from Alpro.

Disinfection of the tapping head

To disinfect the tapping head, unscrew the tip of the probe and wipe off the tapping head with disinfection wipes. Do not use soaking wet wipes. It is very important to avoid the disinfection fluid penetrate into the inner parts of the probe. If you use disinfection sprays, only spray from the side. Do not spray inside the probe, neither from the front side nor from the rear side. Never use oil or lubricants.



Cleaning the tip of the probe

The tip of the probe must always be clean inside. To clean it, unscrew the tip from the probe. Look inside. If you observe impurities, please use the supplied cleaning brush to remove it. After each use of the brush, it must be cleaned, too. Use disinfection foam or spray. The brush will wear out over time. After 10 applications, the brush should not be used any more. A new brush can be ordered, item number 5245758. If the impurities inside the tip of the probe are not too adhesive, you can use cotton buds instead of the brush.



ATTENTION

You should always observe the following instructions for cleaning the Periotest M probe

Do not allow liquids or oil to enter the inner parts of the probe. Do not spray liquids or oil into the probe, neither from the front, nor from the rear side. Repeated entry of such fluids will form a patina which prevents the tapping head from moving easily and results in malfunction. In the longer run, the contacts inside the probe and also in the probe drive will corrode which causes malfunction and can only be repaired by replacing the whole assembly.

Make sure, too, that no cleaning agents may penetrate the Periotest M charger or the power supply unit.

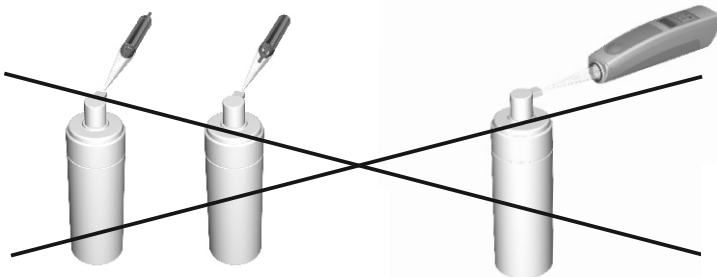

9.2 Sterilization of the Periotest M probe

The Periotest M probe can be sterilized, but only in steam sterilizers (class B) at 134 °C (273 °F), 2.1 bar, 3 minutes holding time. The probe is tested on the surviving of a minimum of 250 sterilization cycles. You can insert the probe wrapped or unwrapped. If you insert it unwrapped, this has the advantage that to a certain extent stains will be removed and you have a cleaning effect. In this case, however, after the sterilization procedure is finished, you need to wait for some time, maybe one hour, until the probe is completely dry outside and inside before inserting it again into the Periotest M housing. Otherwise the humidity can cause malfunction. If you cannot wait that long, put the probe wrapped into the sterilizer.

Once the sterilization procedure is done, the probe is inserted again into the Periotest M housing. Push the probe into the housing as far as it will go. Then turn the probe until it slides a little bit more inside. Then screw the mounting ring again.

ATTENTION

Do not use any tools to screw the mounting ring. Please only screw the mounting ring by hand.

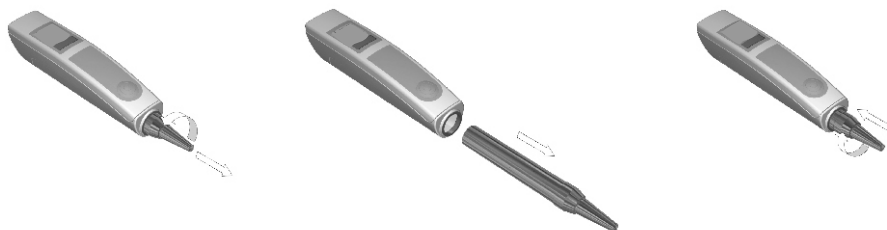

10 Battery

10.1 Charging the battery

The Periotest M is equipped with a lithium-ion polymer (li-ion) storage battery.

WARNINGS

- Only use the supplied battery charging equipment to charge the battery (battery charger REF 8916793 and switch mode power supply unit FRIWO FW8002M/12 REF 8916975). If you use a different charging equipment, the Periotest M and its battery can be damaged.
- The Periotest M battery is built-in and can only be replaced by the manufacturer or an authorized service partner. Do not try to open the Periotest M casing and change the battery by yourself. There is a risk of injury.
- If, after fully charging the battery, it will discharge quickly and LOBAT is shown on the display, or the unit turns off suddenly during a measuring process, the battery has reached its of life and needs to be replaced by the manufacturer or an authorized service partner.
- If the Periotest M has not been in use for a longer period of time, it may not be possible to switch it on and the battery may not be chargeable again. In this case please send the Periotest M to the manufacturer or your dental dealer for a check, or for the replacement of the battery.

Please always charge the battery when LOBAT is shown on the display, or earlier, to ensure the permanent availability of the unit. The battery does not have a „memory effect“. Regarding the frequency or point in time to charge the battery, there is nothing special to keep in mind.

Insert the Periotest M into the charger to charge its battery. The unit can be inserted switched on or switched off. The LED indicates the running charging procedure by blinking green. Once the battery is fully charged, the LED stops blinking and lights up green constantly. It takes approx. 1 hour to fully charge an empty battery. The battery capacity will last for approx. 100 measurements.

11 Maintenance

The Periotest M is basically maintenance-free. There is no need for recalibration or readjustment in regular intervals. If the functional test as described in section 6.2 runs successfully, no maintenance is required. However, if errors occur, during the functional test, occasionally or more frequently, a thorough cleaning of the device, namely the probe, might be necessary. Furthermore, the battery is a wear part that must be replaced, depending on the frequency of use, after 2 - 6 years. In these cases, please disinfect the unit and send it to the manufacturer or your dental dealer (preferably in its original packaging). Please do not try to fix the unit by yourself.

12 Electromagnetic compatibility

12.1 Electromagnetic emission

The UNIT is intended for operation in the electromagnetic environment specified below. The customer or user of the UNIT should make sure that it is used in such an environment.

Emission measurement	Conformity	Electromagnetic environment guidelines
RF emissions according to CISPR 11	Group 1	The UNIT uses RF energy only for its internal function. Therefore, its RF emissions are very low and are not likely to cause any interference in nearby electronic equipment.
RF emissions according to CISPR 11	Class B	The UNIT is intended for use in all facilities, including residential areas and in any facilities connected directly to a public power supply providing electricity to buildings used for residential purposes.
Harmonics according to IEC 61000-3-2	not applicable Power output < 50 W	
Voltage fluctuations/Flicker according to IEC 61000-3-3	not applicable no significant flicker	

12.2 Working clearances

Recommended working clearances between portable and mobile HF communication devices and the UNIT

The UNIT is intended for operation in an electromagnetic environment where radiated HF interference is checked. The customer or the user of the UNIT can help prevent electromagnetic interference by duly observing the minimum distances between portable and/or mobile HF communication devices (transmitters) and the UNIT. These values may vary according to the output power of the relevant communication device as specified below.

Nominal transmitter output [W]	Working clearance according to transmission frequency [m]		
	150 kHz to 80 MHz	80 MHz to 800 MHz	800 MHz to 2.5 GHz
	$d = [1, 2] \cdot \sqrt{P}$	$d = [1, 2] \cdot \sqrt{P}$	$d = [2, 3] \cdot \sqrt{P}$
0,01	0,12	0,12	0,23
0,1	0,38	0,38	0,73
1	1,2	1,2	2,3
10	3,8	3,8	7,3
100	12	12	23

For transmitters whose maximum nominal output is not specified in the above table, the recommended working clearance d in meters (m) can be determined using the equation in the corresponding column, where P is the maximum nominal output of the transmitter in watts (W) specified by the transmitter manufacturer.

Remark 1

The higher frequency range applies at 80 MHz and 800 MHz.

Remark 2

These guidelines may not be applicable in all cases. The propagation of electromagnetic waves is influenced by their absorption and reflection by buildings, objects and persons.

12.3 Interference immunity

The UNIT is intended for operation in the electromagnetic environment specified below. The customer or user of the UNIT should make sure that it is used in such an environment.

Interference immunity tests	IEC 60601-1-2 test level	Compliance level	Electromagnetic environment guidelines
Electrostatic discharge (ESD) according to IEC - 61000-4-2	± 6 kV contact discharge ± 8 kV air discharge	± 6 kV contact discharge ± 8 kV air discharge	Floors should be wood, concrete, or ceramic tile. If floors are covered with synthetic material, the relative humidity should be at least 30 %.
Electrical fast transient/burst according to IEC 61000-4-4	± 1 kV for input and output lines ± 2 kV for power cables	± 1 kV for input and output lines ± 2 kV for power cables	The quality of the line power supply should be that of a typical commercial or hospital environment.
Surge voltages according to IEC 61000-4-5	± 1 kV differential mode ± 2 kV common mode	± 1 kV differential mode ± 2 kV common mode	The quality of the line power supply should be that of a typical commercial or hospital environment.
Voltage dips, short interruptions and variations of the power supply according to IEC 61000-4-11	< 5 % U_T for ½ period (> 95 % dip of U_T) 40 % U_T for 5 periods (60 % dip of U_T) 70 % U_T for 25 periods (30 % dip of U_T) < 5 % U_T for 5 sec. (> 95 % dip of U_T)	< 5 % U_T for ½ period (> 95 % dip of U_T) 40 % U_T for 5 periods (60 % dip of U_T) 70 % U_T for 25 periods (30 % dip of U_T) < 5 % U_T for 5 sec. (> 95 % dip of U_T)	The quality of the line power supply should be that of a typical commercial or hospital environment. If the user of the UNIT requires it to continue functioning following interruptions of the power supply, it is recommended to have the UNIT powered by an uninterrupted power supply or a battery.
Magnetic field of power frequencies (50/60 Hz) according to IEC 61000-4-8	3 A/m	3 A/m	Power frequency magnetic fields should be at levels characteristic of a typical location in a typical commercial or hospital environment.
Remarks: U_T is the AC supply voltage prior to application of the test level.			

Interference Immunity tests	IEC 60601-1-2 test level	Compliance level	Electromagnetic environment guidelines
Conducted HF interference IEC 61000-4-6	$3V_{\text{eff}}$ 150 kHz to 80 MHz ¹	$3V_{\text{eff}}$	<p>Portable and mobile radio equipment must not be used within the recommended working clearance from the UNIT and its cables, which is calculated based on the equation suitable for the relevant transmission frequency.</p> <p>Recommended working clearance:</p> $d = [1, 2] \sqrt{P}$ <p>at 80 MHz to 800 MHz</p> $d = [2, 3] \sqrt{P}$ <p>at 800 MHz to 2.5 GHz</p> <p>Where P is the nominal transmitter output in watts (W) specified by the transmitter manufacturer and d is the recommended working clearance in meters (m).</p> <p>Field strengths from fixed RF transmitters, as determined by an electromagnetic site survey², should be less than the compliance level³ in each frequency range.</p> <p>Interference is possible in the vicinity of equipment bearing the following graphic symbol.</p> 
Radiated HF interference IEC 61000-4-3	$3V/m$ 80MHz to 800MHz ¹ . $3V/m$ 800MHz to 2.5GHz ¹ .	$3V_{\text{eff}}$ $3V_{\text{eff}}$	

1. The higher frequency range applies at 80 MHz and 800 MHz.
2. Field strengths from fixed transmitters, such as base stations for radio (cellular/cordless) telephones and land mobile radios, amateur radio, AM and FM radio broadcast and TV broadcast, cannot be predicted theoretically with accuracy. An investigation of the location is recommended to determine the electromagnetic environment resulting from stationary HF transmitters. If the measured field strength in the location in which the UNIT is used exceeds the applicable RF compliance level above, the UNIT should be observed to verify normal operation. If unusual performance characteristics are observed, it may be necessary to take additional measures such as reorientation or repositioning of the UNIT.
3. Over the frequency range 150 kHz to 80 MHz, field strengths should be less than 3 V/m.

We reserve the right to make any alterations which may be required due to technical improvements.

Revision / Version 2018-02-15

Medizintechnik Gulden e.K.
Eschenweg 3
64397 Modautal
Germany
www.med-gulden.com

Order no. 8920165

Printed in Germany